

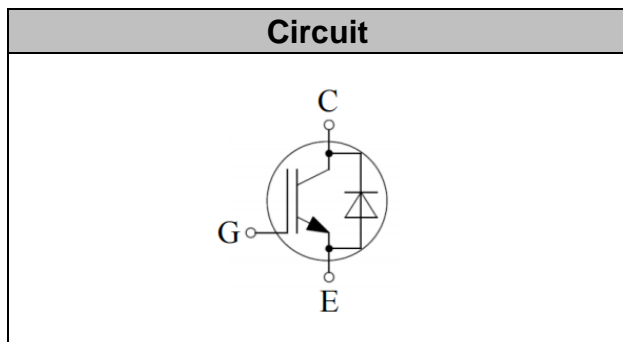

IGBT Discrete

V_{CE}	650	V
I_C	100	A
$V_{CE(SAT)} I_C=100A$	1.25	V



Applications

- General purpose inverters
- Motor drives
- Uninterruptible power supply

Features

- High speed smooth switching device for hard & soft switching
- Maximum junction temperature 175°C
- Positive temperature coefficient
- High ruggedness, temperature stable

Maximum Ratings

Parameter	Symbol	Value	Unit
Collector-Emitter Breakdown Voltage	V_{CE}	650	V
DC Collector Current, limited by T_{jmax} $T_C=25^\circ C$ value limited by bondwire $T_C=100^\circ C$	I_C	160 100	A
Diode Forward Current, limited by T_{jmax} $T_C=25^\circ C$ value limited by bondwire $T_C=100^\circ C$	I_F	160 100	A
Continuous Gate-Emitter Voltage	V_{GE}	± 20	V
Transient Gate-Emitter Voltage ($t_p \leq 10\mu s, D < 0.010$)	V_{GE}	± 30	V
Turn off Safe Operating Area $V_{CE} \leq 650V$, $T_j \leq 150^\circ C$		400	A
Pulsed Collector Current, $V_{GE}=15V$, t_p limited by T_{jmax}	I_{CM}	400	A
Diode Pulsed Current, t_p limited by T_{jmax}	I_{Fpuls}	400	A
Power Dissipation, $T_j=175^\circ C, T_C=25^\circ C$	P_{tot}	428	W



Operating Junction Temperature	T_j	-40...+175	°C
Storage Temperature	T_s	-55...+150	°C
Soldering Temperature, wave soldering 1.6mm (0.063in.) from case for 10s		260	°C

Electrical Characteristics of the IGBT ($T_j = 25^\circ\text{C}$ unless otherwise specified):

Parameter	Symbol	Conditions	Min.	Typ.	Max.	Unit
Static						
Collector-Emitter Breakdown Voltage	BV_{CES}	$V_{GE}=0V, I_C=250\mu A$	650		-	V
Gate Threshold Voltage	$V_{GE(th)}$	$V_{GE}=V_{CE}, I_C=1.20mA$	4.25	4.75	5.25	V
Collector-Emitter Saturation Voltage	$V_{CE(sat)}$	$V_{GE}=15V, I_C=100A$ $T_j=25^\circ\text{C}$, $T_j=125^\circ\text{C}$ $T_j=150^\circ\text{C}$	0.90	1.25 1.35 1.40	1.60	V
Zero Gate Voltage Collector Current	I_{CES}	$V_{CE}=650V, V_{GE}=0V$ $T_j=25^\circ\text{C}$, $T_j=150^\circ\text{C}$			0.25 3.00	mA
Gate-Emitter Leakage Current	I_{GES}	$V_{CE}=0V, V_{GE}=\pm 20V$			200	nA

Parameter	Symbol	Conditions	Min.	Typ.	Max.	Unit
Dynamic						
Input Capacitance	C_{ies}	$V_{CE}=25V, V_{GE}=0V,$ $f=1MHz$	-	5.13	-	nF
Reverse Transfer Capacitance	C_{res}		-	0.05	-	
Gate Charge	Q_G	$V_{CC}=300V, I_C=100A,$ $V_{GE}=-5V\sim+15V$	-	0.26	-	uC

**Electrical Characteristics of the Diode** ($T_j = 25^\circ\text{C}$ unless otherwise specified):

Parameter	Symbol	Conditions	Min.	Typ.	Max.	Unit
Static						
Diode Forward Voltage	V_F	$I_F = 100\text{A}$ $T_j = 25^\circ\text{C}$, $T_j = 125^\circ\text{C}$ $T_j = 150^\circ\text{C}$		1.40 1.35 1.30	1.90	V

Switching Characteristic, Inductive Load

Parameter	Symbol	Conditions	Min.	Typ.	Max.	Unit
Dynamic , at $T_j = 25^\circ\text{C}$						
Turn-on Delay Time	$t_{d(on)}$	$V_{CC} = 300\text{V}$, $I_C = 100\text{A}$, $V_{GE} = -5\text{V} \sim 15\text{V}$, $R_g = 10\Omega$ Inductive Load	-	26	-	ns
Rise Time	t_r		-	110	-	ns
Turn-on Energy	E_{on}		-	4.0	-	mJ
Turn-off Delay Time	$t_{d(off)}$		-	204	-	ns
Fall Time	t_f		-	100	-	ns
Turn-off Energy	E_{off}		-	2.4	-	mJ
Total switching energy	E_{ts}		-	6.4	-	mJ
Dynamic , at $T_j = 125^\circ\text{C}$						
Turn-on Delay Time	$t_{d(on)}$	$V_{CC} = 300\text{V}$, $I_C = 100\text{A}$, $V_{GE} = -5\text{V} \sim 15\text{V}$, $R_g = 10\Omega$ Inductive Load	-	27	-	ns
Rise Time	t_r		-	97	-	ns
Turn-on Energy	E_{on}		-	4.1	-	mJ
Turn-off Delay Time	$t_{d(off)}$		-	232	-	ns
Fall Time	t_f		-	138	-	ns
Turn-off Energy	E_{off}		-	3.1	-	mJ
Total switching energy	E_{ts}		-	7.2	-	mJ
Dynamic , at $T_j = 150^\circ\text{C}$						
Turn-on Delay Time	$t_{d(on)}$	$V_{CC} = 300\text{V}$, $I_C = 100\text{A}$, $V_{GE} = -5\text{V} \sim 15\text{V}$, $R_g = 10\Omega$ Inductive Load	-	27	-	ns
Rise Time	t_r		-	90	-	ns
Turn-on Energy	E_{on}		-	4.2	-	mJ
Turn-off Delay Time	$t_{d(off)}$		-	240	-	ns
Fall Time	t_f		-	153	-	ns
Turn-off Energy	E_{off}		-	3.4	-	mJ
Total switching energy	E_{ts}		-	7.6	-	mJ



Electrical Characteristics of the DIODE

Parameter	Symbol	Conditions	Min.	Typ.	Max.	Unit
Dynamic , at T_j= 25°C						
Reverse Recovery Current	I _{rr}	I _F =100A, V _R =300V -di/dt=550A/μs,	-	23	-	A
Reverse Recovery Charge	Q _{rr}		-	1.8	-	uC
Diode reverse recovery time	trr		-	116	-	ns
Reverse Recovery Energy	E _{rec}		-	0.16	-	mJ
Dynamic , at T_j= 125°C						
Reverse Recovery Current	I _{rr}	I _F =100A, V _R =300V -di/dt=550A/μs,	-	36	-	A
Reverse Recovery Charge	Q _{rr}		-	4.2	-	uC
Diode reverse recovery time	trr		-	158	-	ns
Reverse Recovery Energy	E _{rec}		-	0.47	-	mJ
Dynamic , at T_j= 150°C						
Reverse Recovery Current	I _{rr}	I _F =100A, V _R =300V -di/dt=550A/μs,	-	41	-	A
Reverse Recovery Charge	Q _{rr}		-	5.7	-	uC
Diode reverse recovery time	trr		-	197	-	ns
Reverse Recovery Energy	E _{rec}		-	0.61	-	mJ

Thermal Resistance

Parameter	Symbol	Max. Value	Unit
IGBT Thermal Resistance, Junction - Case	R _{th(j-c)}	0.35	K/W
Diode Thermal Resistance, Junction - Case	R _{th(j-c)}	0.45	K/W
Thermal Resistance, Junction - Ambient	R _{th(j-a)}	40	K/W

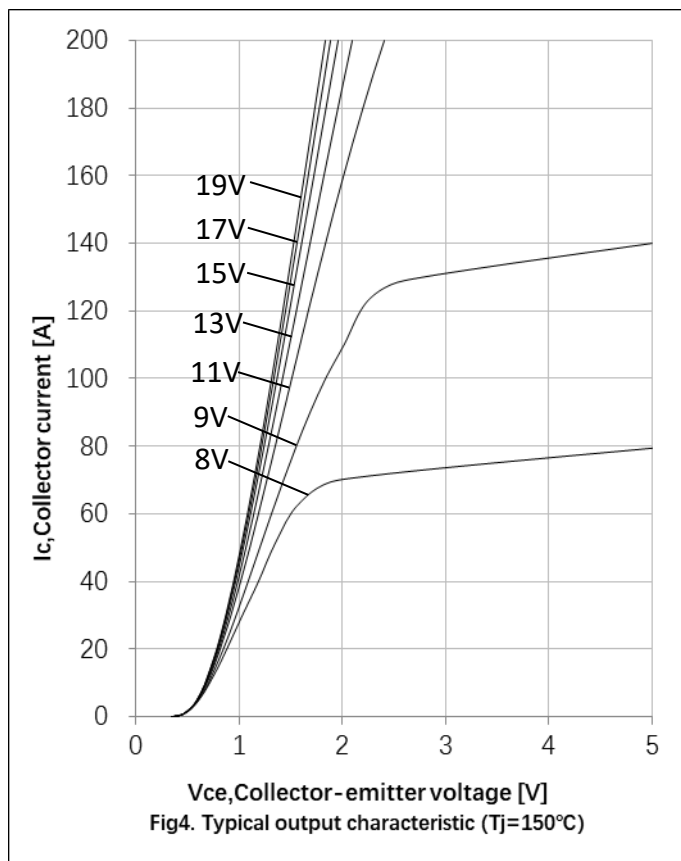
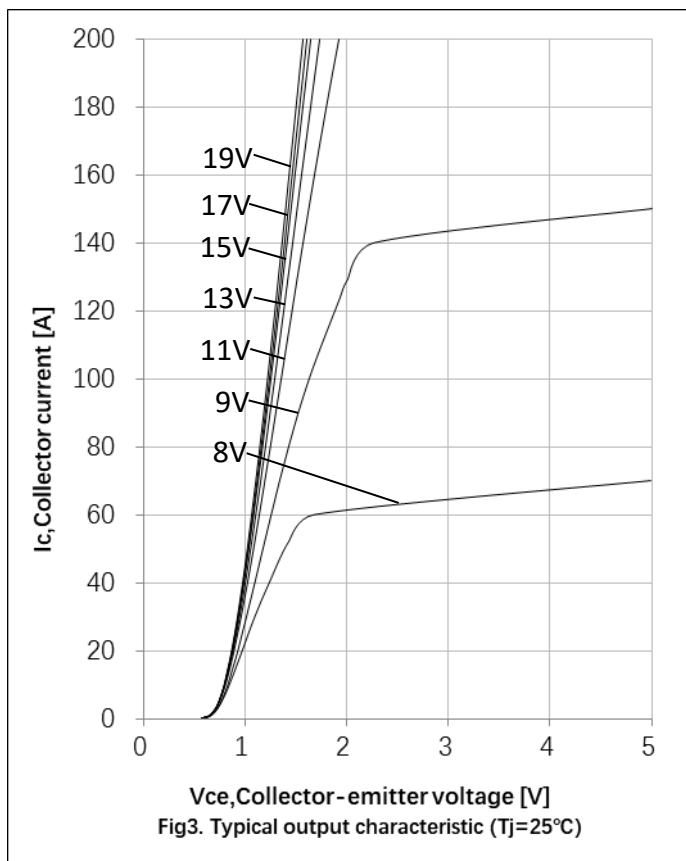
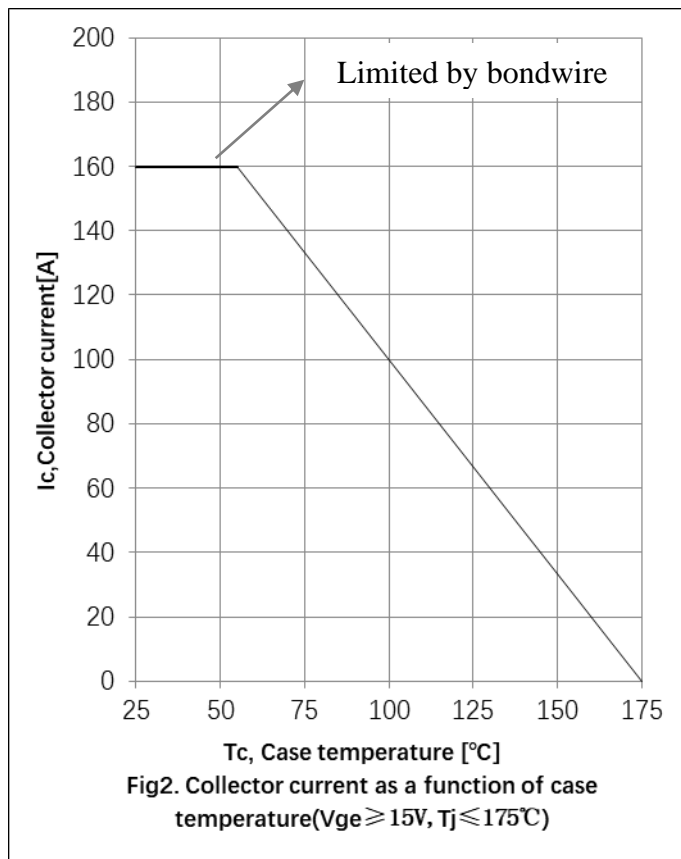
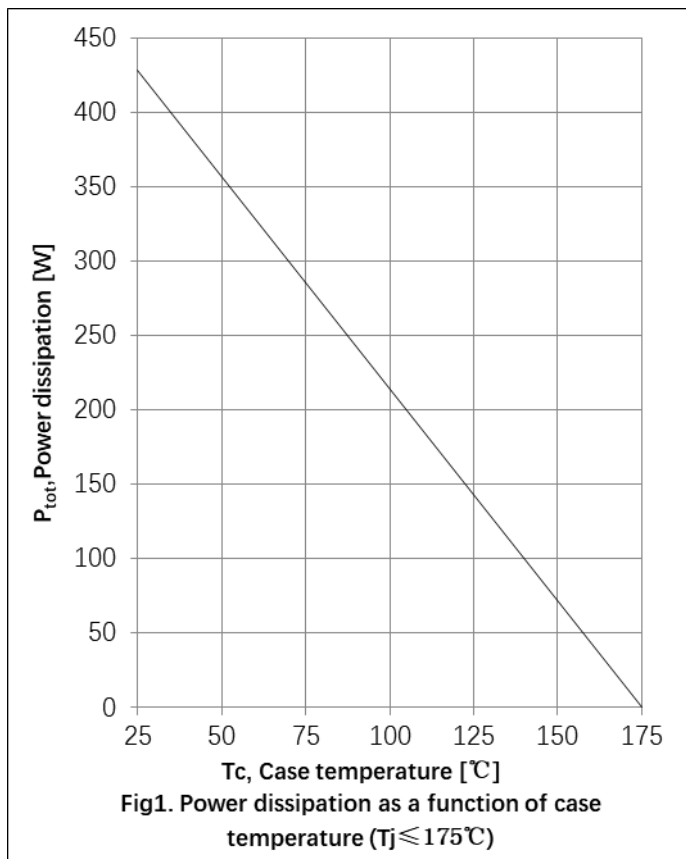

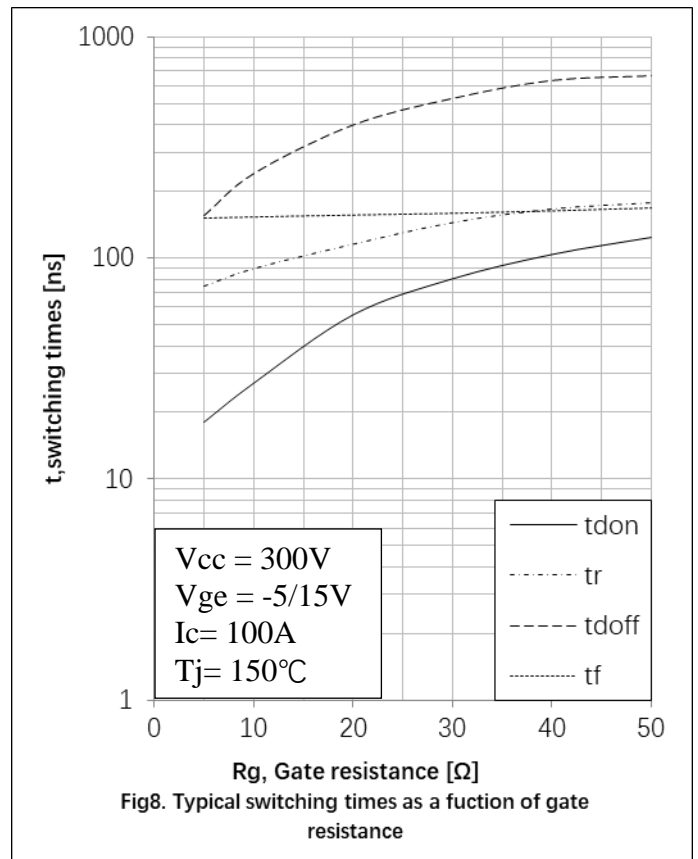
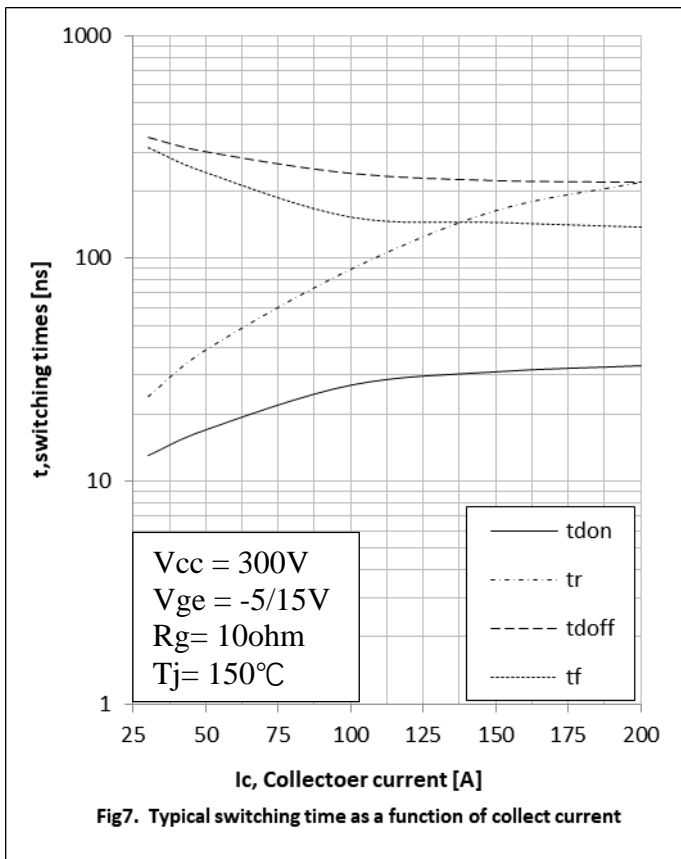
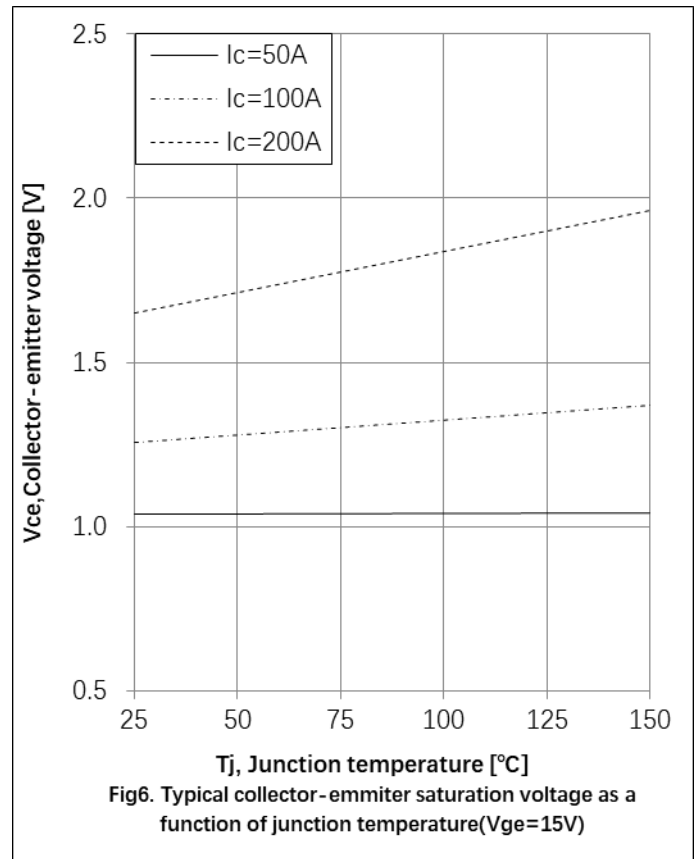
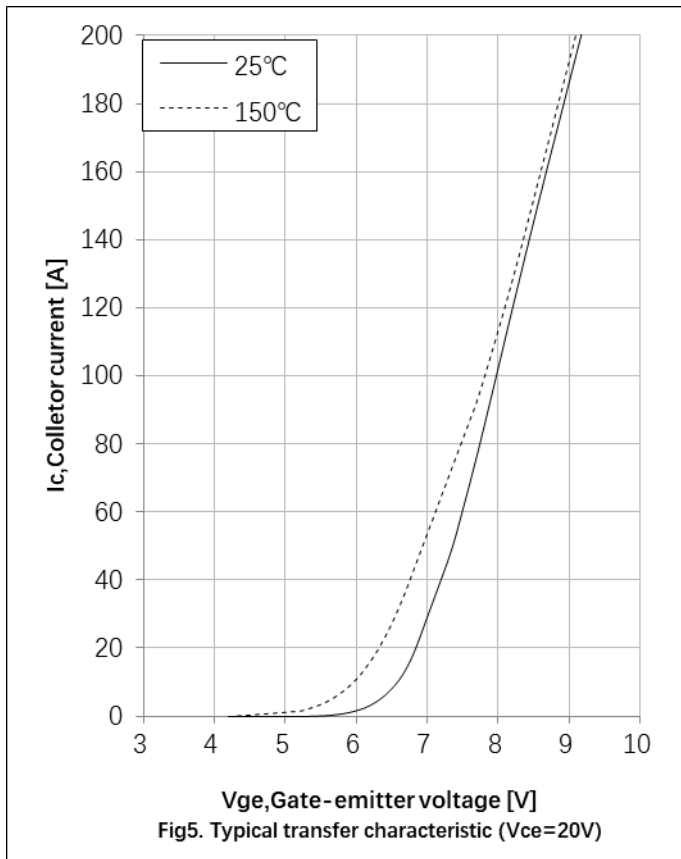

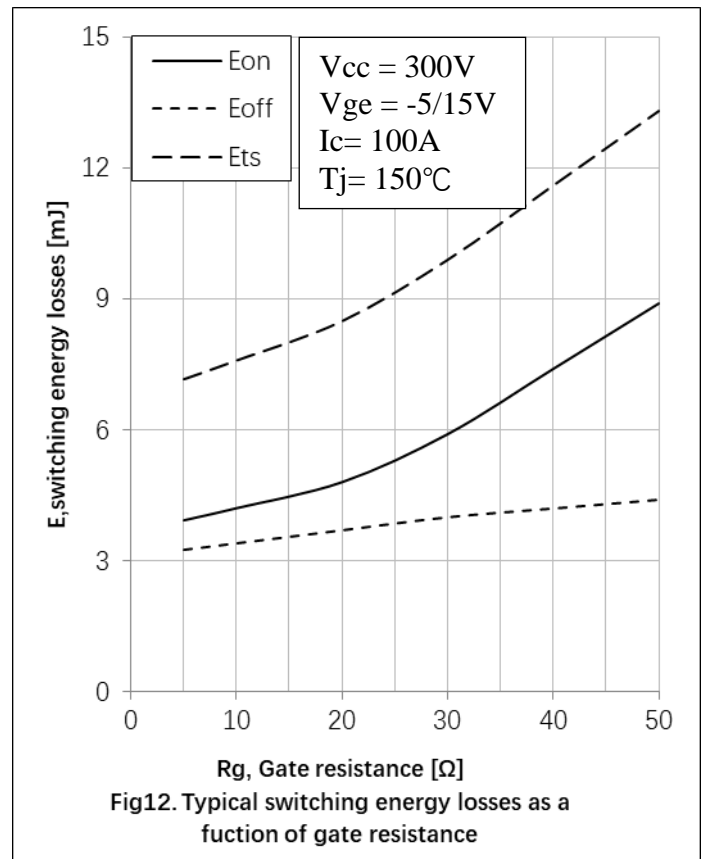
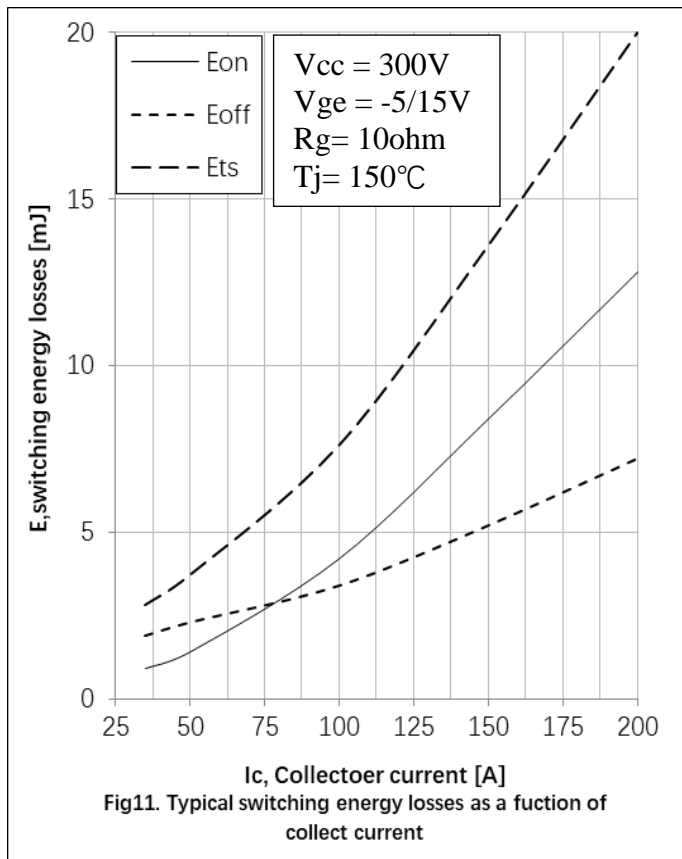
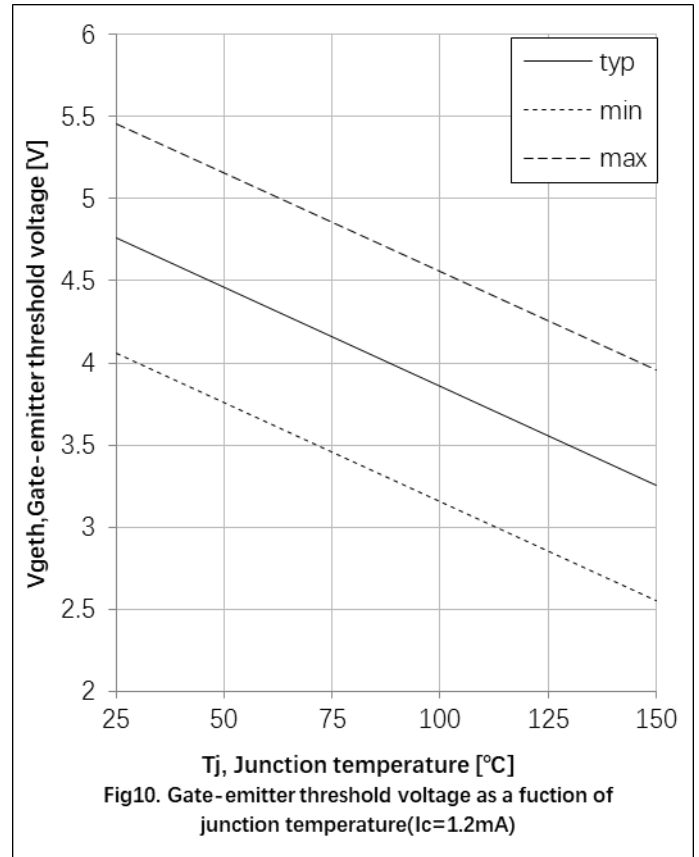
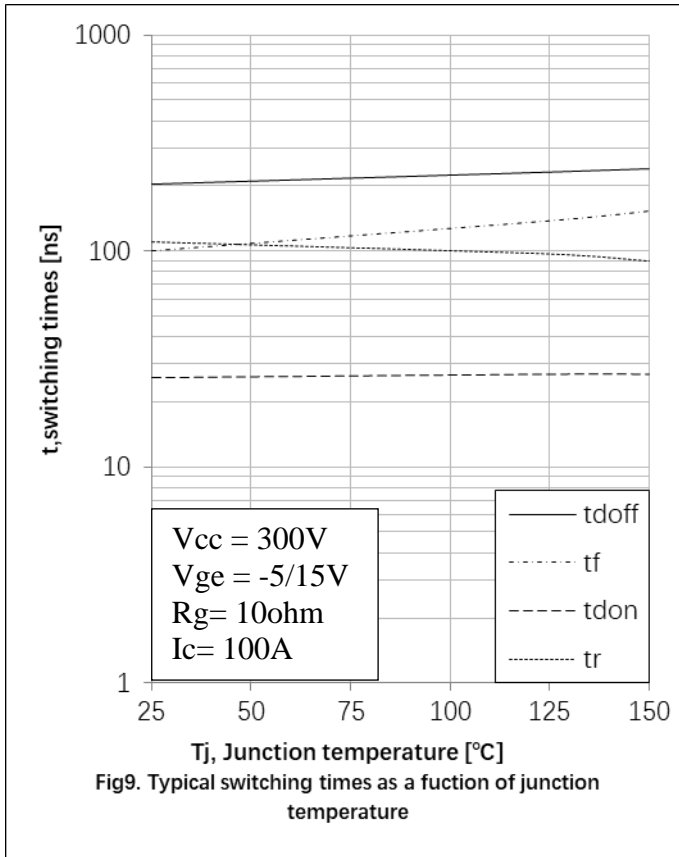

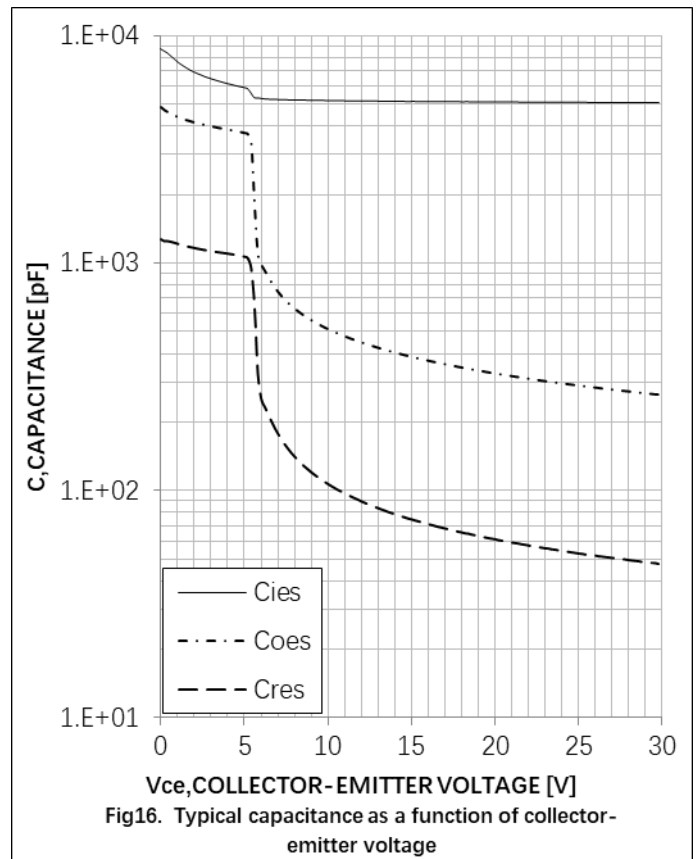
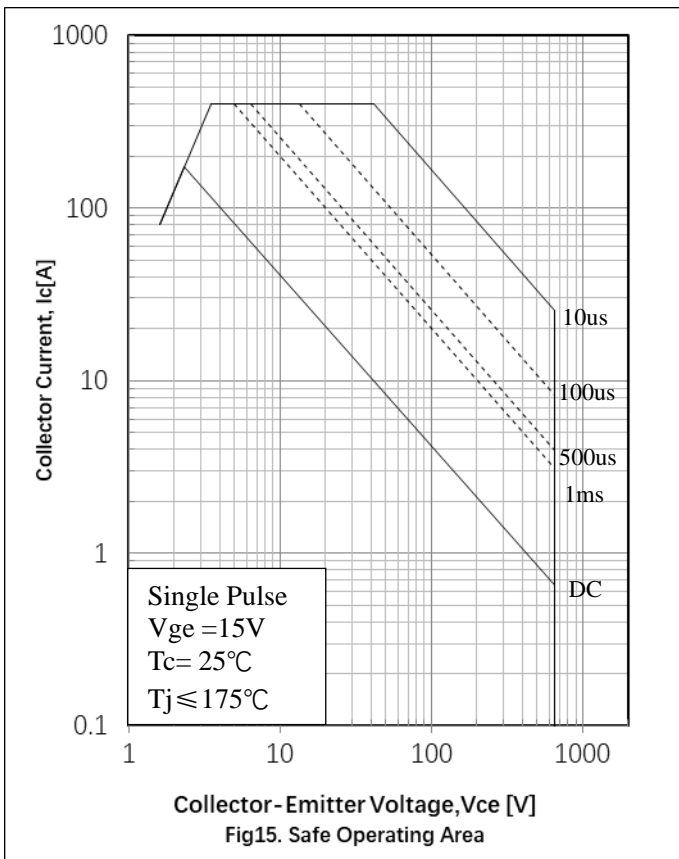
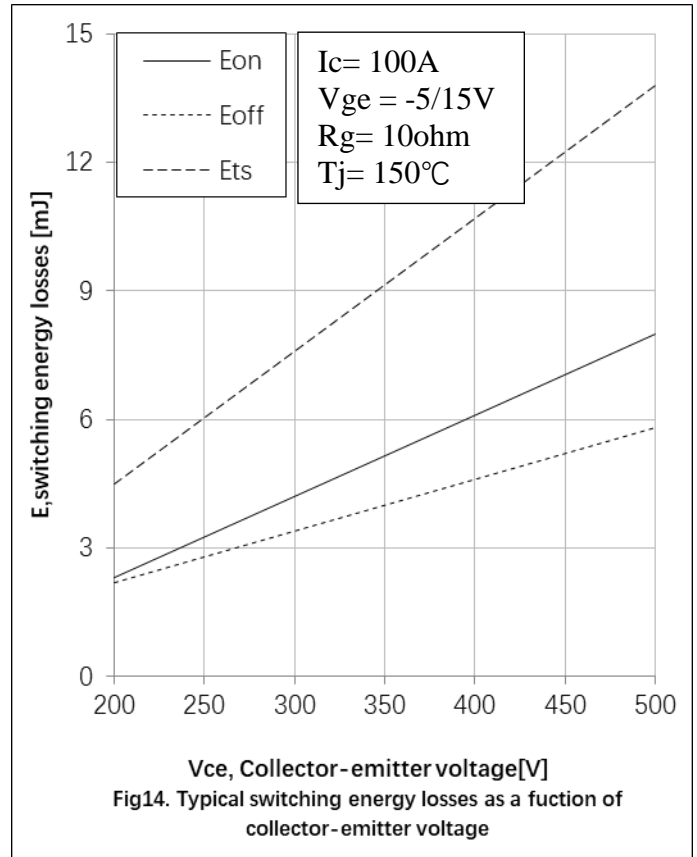
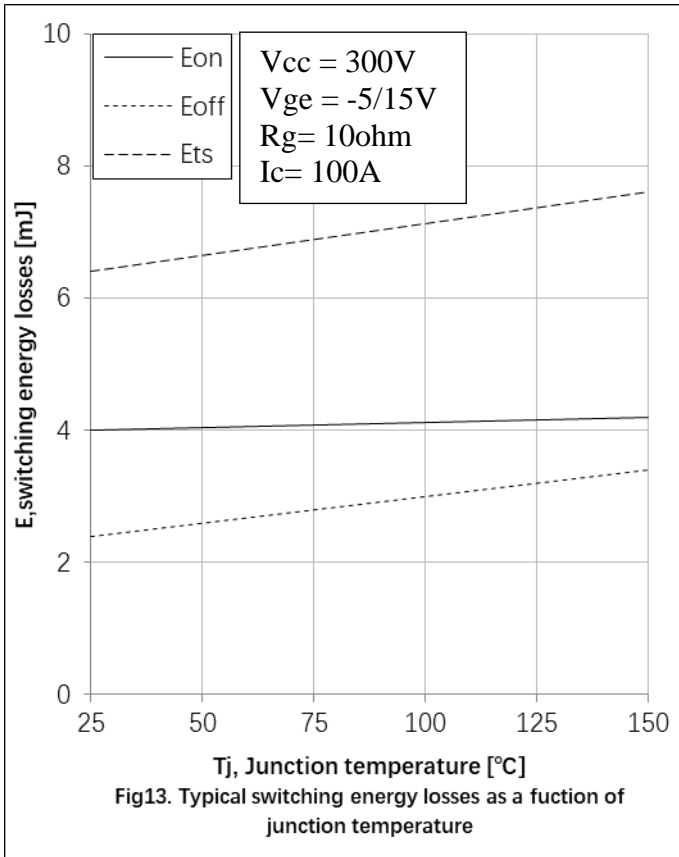

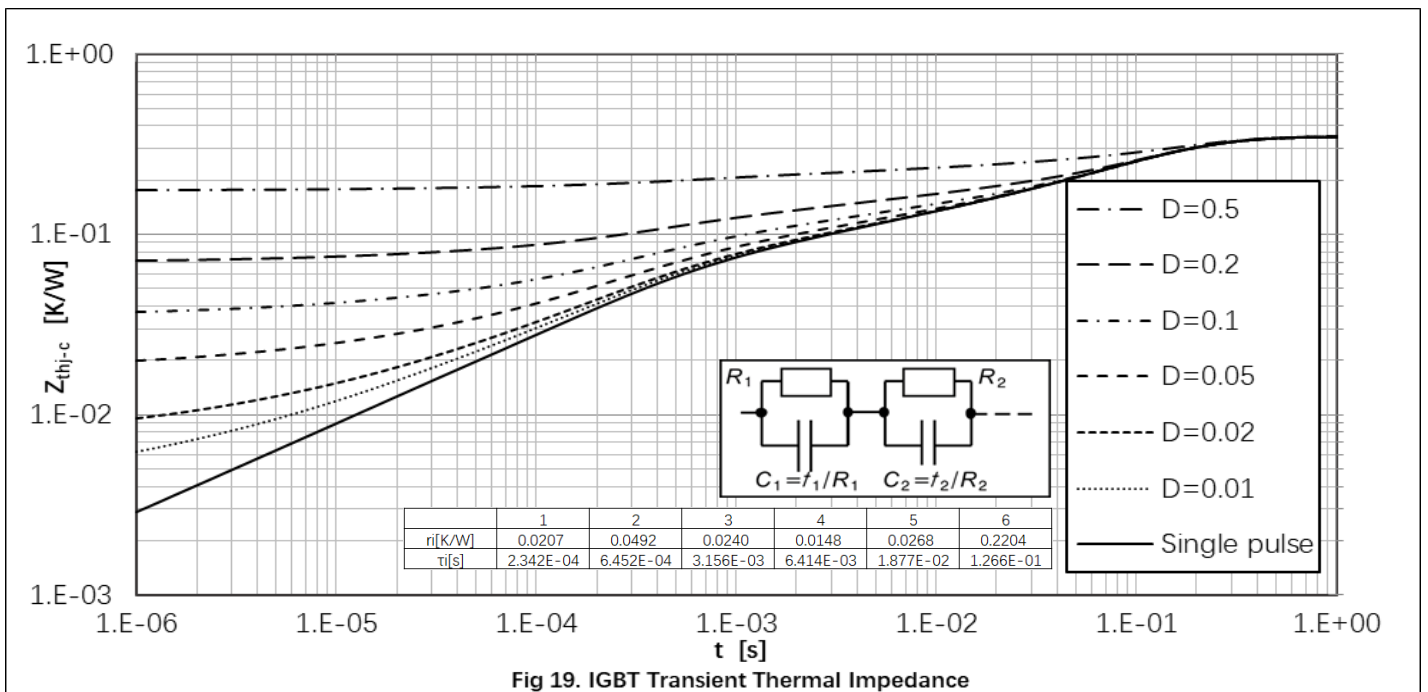
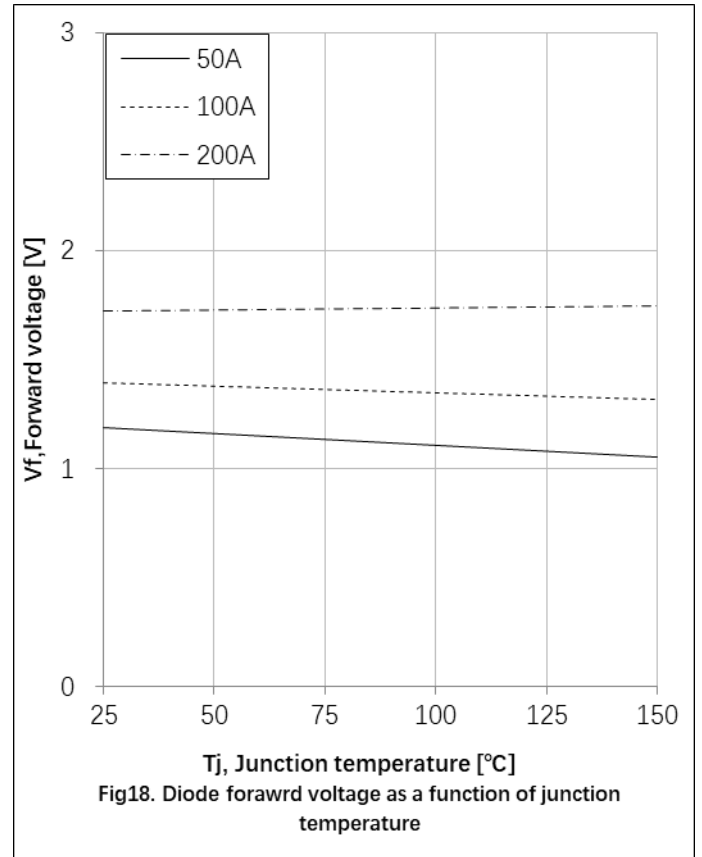
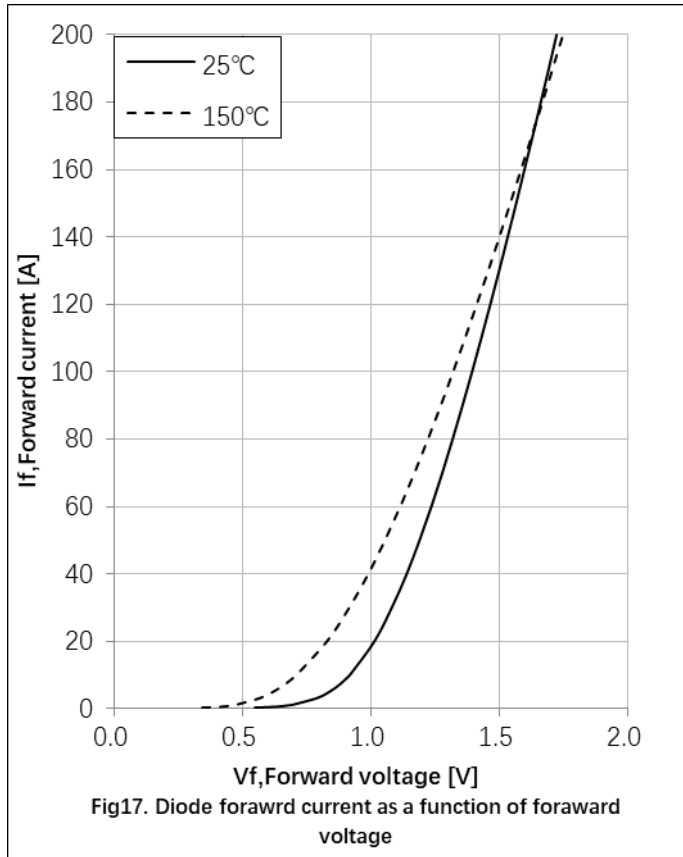

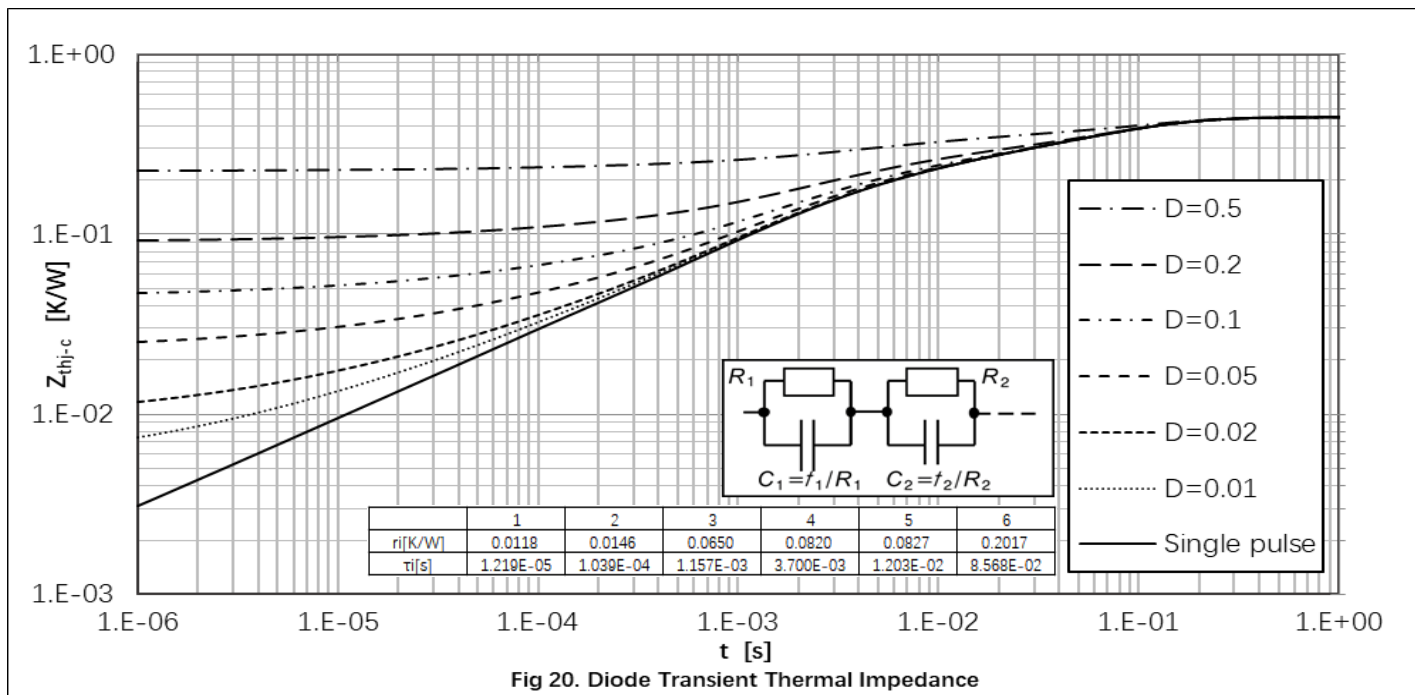

● **Circuit Diagram**

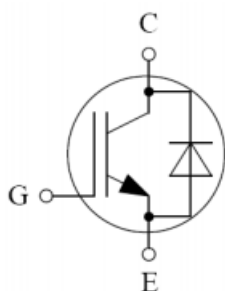

● **Package Outline Information**

CASE: TO 247

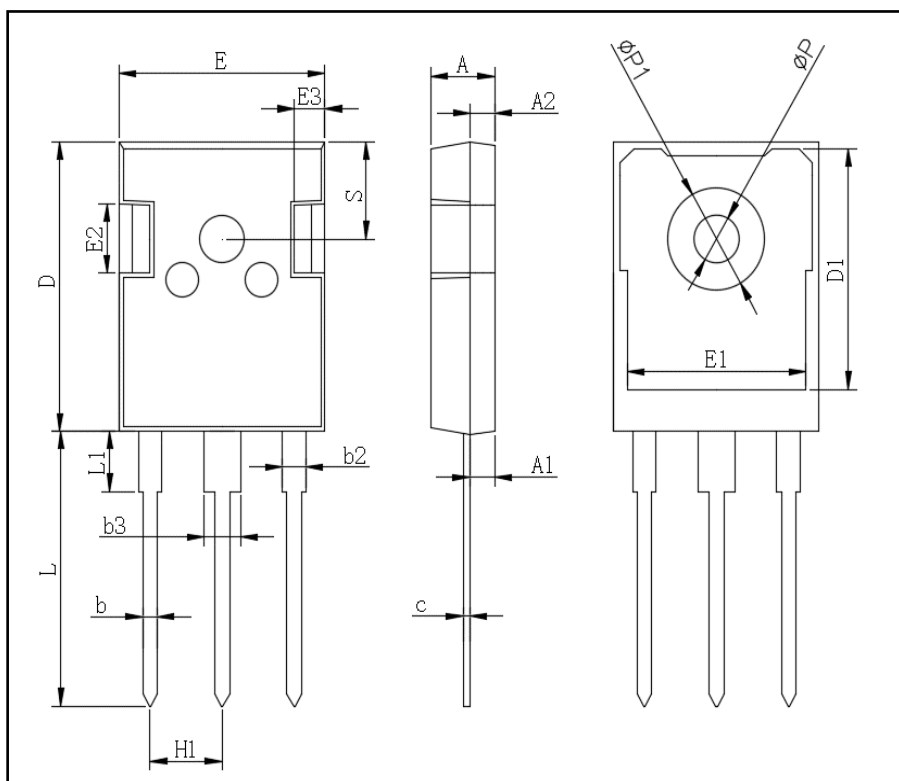

TO-247AB		
Dim	Min	Max
A	4.80	5.20
A1	2.21	2.61
A2	1.85	2.15
b	1.0	1.4
b2	1.91	2.21
C	0.5	0.7
D	20.70	21.30
D1	16.25	16.85
E	15.50	16.10
E1	13.0	13.6
E2	4.80	5.20
E3	2.30	2.70
L	19.62	20.22
L1	-	4.30
ΦP	3.40	3.80
ΦP1	-	7.30
S	6.15TYP	
H1	5.44TYP	
b3	2.80	3.20