

## High Speed Switching Diode

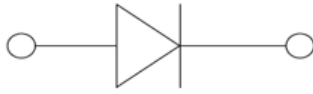

**SOD323**

### Features

- Epoxy meets UL-94 V-0 flammability rating and halogen free
- Moisture Sensitivity Level 1
- $V_{RRM}$  75V
- $I_{FAV}$  250mA
- Part no. with suffix "Q" means AEC-Q101 qualified

### Applications

- Extreme fast switches
- Automotive

### Mechanical Data

- **Case:** SOD323
- **Terminals:** Tin plated leads, solderable per J-STD-002 and JESD22-B102
- **Polarity:** Cathode line denotes the cathode end
- **Marking:** T5

### ■ Maximum Ratings ( $T_a=25^\circ\text{C}$ Unless otherwise specified)

PARAMETER	SYMBOL	UNIT	CONDITIONS	VALUE
Repetitive Peak Reverse Voltage	$V_{RRM}$	V		75
Peak Forward Surge Current	$I_{FSM}$	A	Pulse width = 1 $\mu$ s	2
Average Forward Current	$I_{FAV}$	mA		250
Power Dissipation	$P_{tot}$	mW		200
Thermal Resistance	$R_{thJA}$	K/W		625
Junction Temperature	$T_j$	$^\circ\text{C}$		-55 to +150
Storage Temperature Range	$T_{stg}$	$^\circ\text{C}$		-55 to +150



# 1N4448WSQ

## ■ Electrical Characteristics (T<sub>a</sub>=25°C Unless otherwise specified)

PARAMETER	SYMBOL	UNIT	CONDITIONS	MIN	MAX
Forward Voltage	V <sub>F</sub>	V	IF=5mA		0.72
			IF=10mA		0.855
			IF=50mA		1.0
			IF=150mA		1.25
Reverse Current	I <sub>R</sub>	nA	V <sub>R</sub> =20V		25
	I <sub>R</sub>	nA	V <sub>R</sub> =75V		200
Breakdown Voltage	V <sub>R</sub>	V	I <sub>R</sub> =100μA	75	
Junction Capacitance	C <sub>j</sub>	pF	V <sub>R</sub> =V <sub>F</sub> =0V, f =1MHz		4
Reverse Recovery Time	t <sub>rr</sub>	ns	I <sub>F</sub> =10mA, I <sub>rr</sub> =0.1I <sub>R</sub> , R <sub>L</sub> =100Ω		4

## ■ Ordering Information (Example)

PREFERRED P/N	PACKING CODE	UNIT WEIGHT(g)	MINIMUM PACKAGE(pcs)	INNER BOX QUANTITY(pcs)	OUTER CARTON QUANTITY(pcs)	DELIVERY MODE
1N4448WSQ	F2	Approximate 0.0045	3000	30000	120000	7" reel



# 1N4448WSQ

## ■ Characteristics (Typical)

Fig.1:  $P_D-T_A$

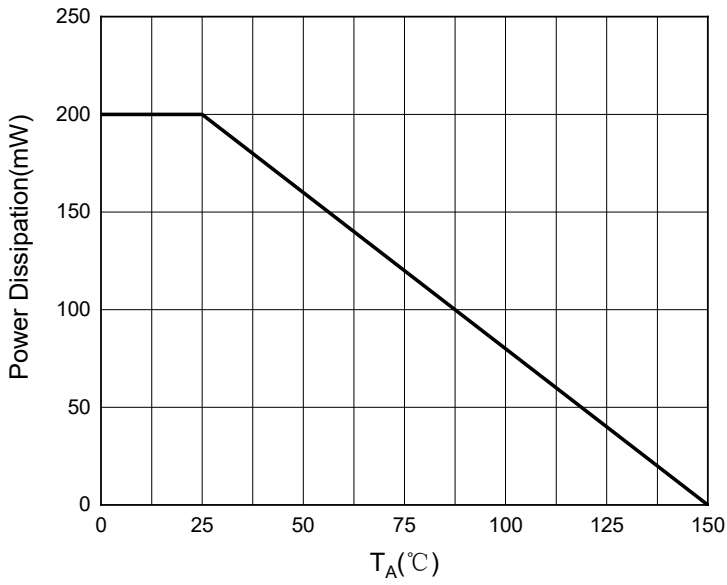

Fig.2: Capacitance Characteristics

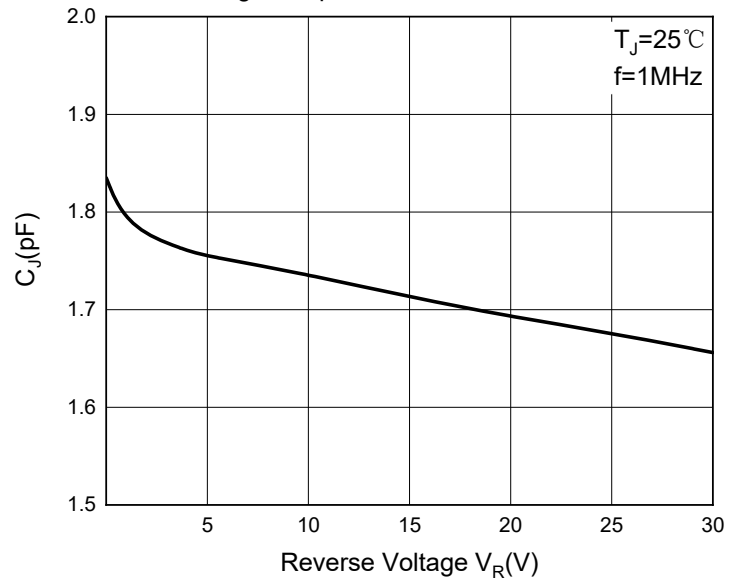

Fig.3: Forward Characteristics

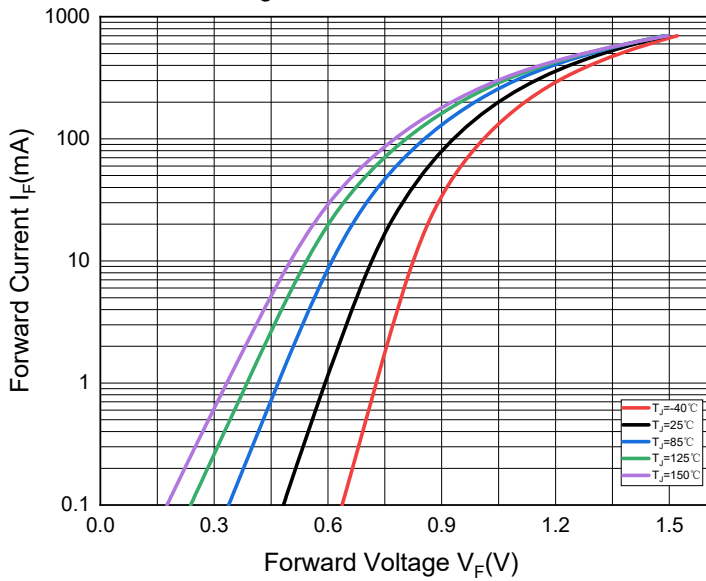
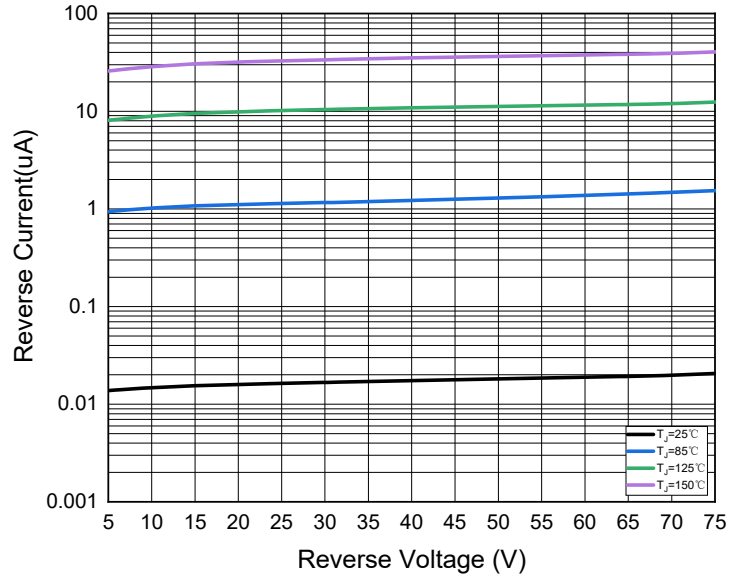

Fig.4: Reverse Characteristics





# 1N4448WSQ

## ■ Outline Dimensions

SOD-323

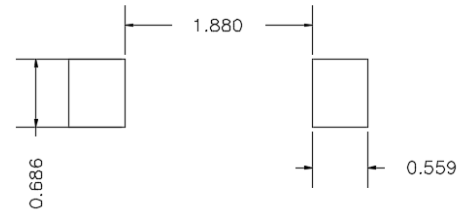
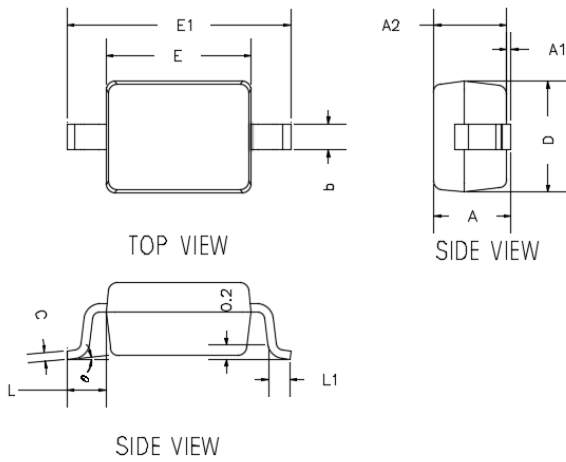

UNIT: mm

SUGGESTED SOLDER PAD LAYOUT

DIMENSIONS				
DIM	INCHES		MM	
	MIN	MAX	MIN	MAX
A	---	0.0393	---	1.0000
A1	0.0000	0.0039	0.0000	0.1000
A2	0.0314	0.0354	0.8000	0.9000
b	0.0098	0.0157	0.2500	0.4000
c	0.0031	0.0059	0.0800	0.1500
D	0.0472	0.0551	1.2000	1.4000
E	0.0629	0.0709	1.6000	1.8000
E1	0.0984	0.1063	2.5000	2.7000
L	0.0187TYP		0.475TYP	
L1	0.0098	0.0157	0.250	0.400
θ	0°	8°	0°	8°

## ■ Marking Information

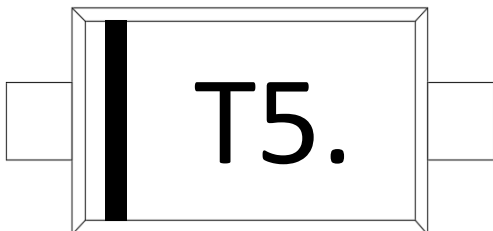

Note:

1. All marking is at middle of the product body
2. All marking is in laser marking
3. Body color: Black



# 1N4448WSQ

---

## Disclaimer

The information presented in this document is for reference only. Yangzhou Yangjie Electronic Technology Co., Ltd. reserves the right to make changes without notice for the specification of the products displayed herein to improve reliability, function or design or otherwise.

The product listed herein is designed to be used with automotive electronics, are not designed for use in medical, life-saving, life-sustaining, or military, Yangjie or anyone on its behalf, assumes no responsibility or liability for any damages resulting from such improper use of sale.

This publication supersedes & replaces all information previously supplied. For additional information, please visit our website [http:// www.21yangjie.com](http://www.21yangjie.com) , or consult your nearest Yangjie's sales office for further assistance.