

Dual NPN+PNP Small Signal Transistor

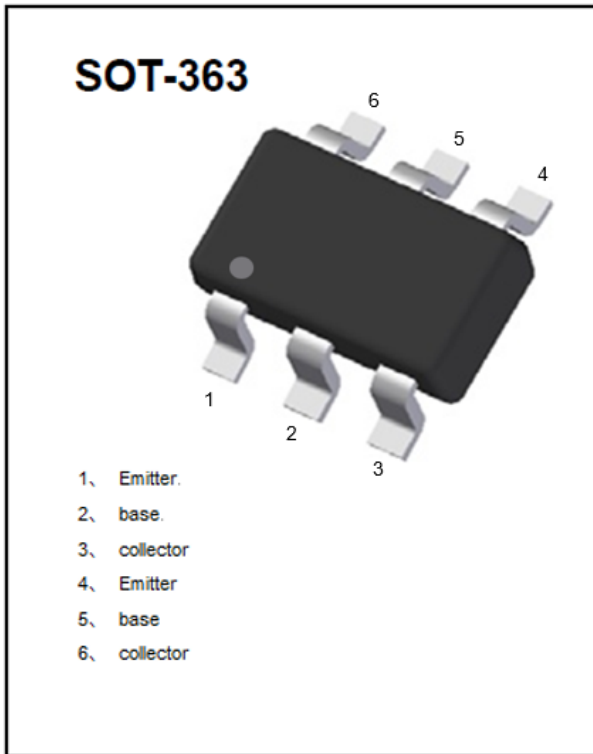

Features

- Epoxy meets UL-94 V-0 flammability rating
- Surface mount package ideally Suited for Automatic Insertion
- NPN/PNP

Mechanical Data

- **Package:** SOT-363
- **Terminals:** Tin plated leads, solderable per J-STD-002 and JESD22-B102
- **Marking:** K46

Equivalent circuit

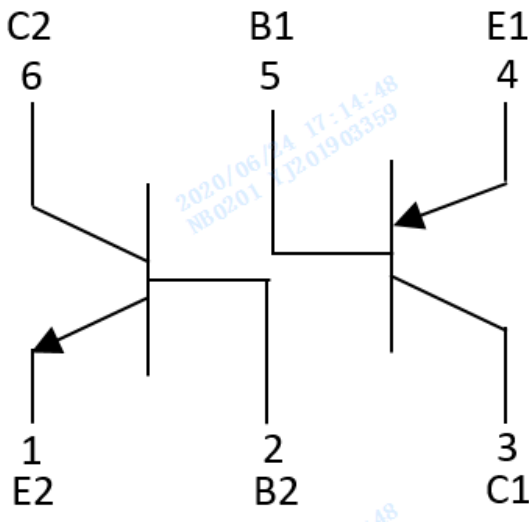

Ordering Information (Example)

PREFERED P/N	PACKING CODE	UNIT WEIGHT(g)	MINIMUM PACKAGE(pcs)	INNER BOX QUANTITY(pcs)	OUTER CARTON QUANTITY(pcs)	DELIVERY MODE
MMDT3946	F2	Approximate 0.009g	3000	30000	120000	7" reel



MMDT3946

■TR1 NPN Pin1、 2、 6 Maximum Ratings (Ta=25°C Unless otherwise specified)

Item	Symbol	Unit	Conditions	Value
Collector-Base Voltage	V_{CBO}	V	$I_C=10\mu A, I_E=0$	60
Collector-Emitter Voltage	V_{CEO}	V	$I_C=1mA, I_B=0$	40
Emitter-Base Voltage	V_{EBO}	V	$I_E=10\mu A, I_C=0$	6
Collector Current -Continuous	I_C	mA		200
Total Device Dissipation	P_C	mW		200
Junction Temperature	T_J	°C		150
Storage Temperature	T_{STG}	°C		-55 to +150

■TR1 NPN Pin1、 2、 6 Electrical Characteristics (Ta=25°C unless otherwise specified)

Item	Symbol	Unit	Conditions	Min	TYP	Max
Collector-base breakdown voltage	V_{CBO}	V	$I_C=10\mu A, I_E=0$	60		
Collector-emitter breakdown voltage	V_{CEO}	V	$I_C=1mA, I_B=0$	40		
Emitter-base breakdown voltage	V_{EBO}	V	$I_E=10\mu A, I_C=0$	6		
Collector cut-off current	I_{CBO}	nA	$V_{CB}=30V, I_E=0$			50
Collector cut-off current	I_{CEO}	nA	$V_{CE}=30V, I_B=0$			50
Collector cut-off current	I_{EBO}	nA	$V_{EB}=5V, I_C=0$			50
DC current gain	h_{FE1}		$V_{CE}=1V, I_C=0.1mA$	40		
	h_{FE2}		$V_{CE}=1V, I_C=1mA$	70		
	h_{FE3}		$V_{CE}=1V, I_C=10mA$	100		300
	h_{FE4}		$V_{CE}=1V, I_C=50mA$	60		
	h_{FE5}		$V_{CE}=1V, I_C=100mA$	30		
Collector-emitter saturation voltage	$V_{CE(sat)}$	V	$I_C=10mA, I_B=1mA$			0.2
		V	$I_C=50mA, I_B=5mA$			0.3
Base-emitter saturation voltage	$V_{BE(sat)}$	V	$I_C=10mA, I_B=1mA$	0.65		0.85
		V	$I_C=50mA, I_B=5mA$			0.95
Transition frequency	f_T	MHz	$V_{CE}=20V, I_C=20mA, f=100MHz$	300		
Delay Time	t_d	ns	$V_{CC}=3V, I_C=10mA, V_{BE}=0.5V, I_{B1}=1mA$			35
Rise Time	t_r	ns				35
Storage Time	t_s	ns	$V_{CC}=3V, I_C=10mA, I_{B1}=-I_{B2}=1mA$			200
Fall Time	t_f	ns				50
Output capacitance	C_{ob}	pF	$V_{CB}=5V, I_E=0A, f=1MHz$			4



MMDT3946

■TR2 PNP Pin3、4、5 Maximum Ratings (Ta=25°C Unless otherwise specified)

Item	Symbol	Unit	Conditions	Value
Collector-Base Voltage	VCBO	V	IC=-10μA,IE=0	-40
Collector-Emitter Voltage	VCEO	V	IC=-1mA,IB=0	-40
Emitter-Base Voltage	VEBO	V	IE=-10μA,IC=0	-5
Collector Current	IC	mA		-200
Total Device Dissipation	PC	mW		200
Junction Temperature	Tj	°C		150
Storage Temperature	TSTG	°C		-55 to +150

■TR2 PNP Pin3、4、5 Electrical Characteristics (Ta=25°C unless otherwise specified)

Item	Symbol	Unit	Conditions	Min	TYP	Max
Collector-base breakdown voltage	V _{CBO}	V	IC=-10μA,IE=0	-40		
Collector-emitter breakdown voltage	V _{CEO}	V	IC=-1mA,IB=0	-40		
Emitter-base breakdown voltage	V _{EBO}	V	IE=-10μA,IC=0	-5		
Collector-Base cut-off current	I _{CBO}	nA	VCB=-30V,IE=0			-50
Emitter-Base cut-off current	I _{EBO}	nA	VEB=-5V,IC=0			-50
DC current gain	h _{FE1}		VCE=-1V,IC=-0.1mA	40		
	h _{FE2}		VCE=-1V,IC=-1mA	70		
	h _{FE3}		VCE=-1V,IC=-10mA	100		300
	h _{FE4}		VCE=-1V,IC=-50mA	60		
	h _{FE5}		VCE=-1V,IC=-100mA	30		
Collector-emitter saturation voltage	V _{CE(sat)}	V	IC=-10mA,IB=-1mA			-0.25
		V	IC=-50mA,IB=-5mA			-0.4
Base-emitter saturation voltage	V _{BE(sat)}	V	IC=-10mA,IB=-1mA	-0.65		-0.85
		V	IC=-50mA,IB=-5mA			-0.95
Transition frequency	f _T	MHz	VCE=-20V,IE=-10mA,f=100MHz	250		
Delay Time	td	ns	VCC=-3V, IC=-10mA, VBE=-0.5V, IB1=-1mA			35
Rise Time	tr	ns				35
Storage Time	ts	ns	VCC=-3V, IC=-10mA, IB1=-IB2=-1mA			225
Fall Time	tf	ns				75
Output capacitance	Cob	pF	VCB=-5V,IE=0A,f=1MHz			4.5



MMDT3946

■ TR1 NPN Pin1、2、6 Characteristics (Typical)

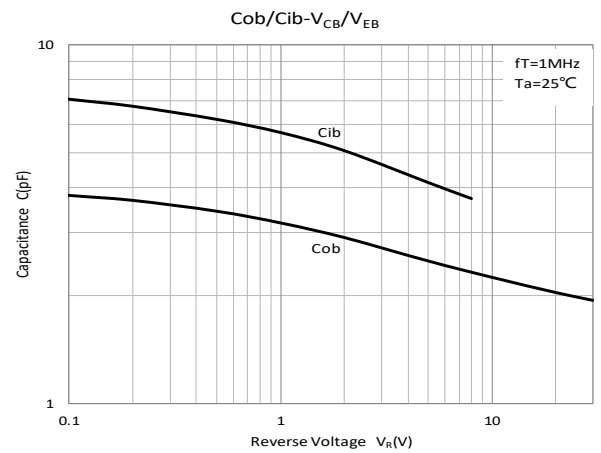
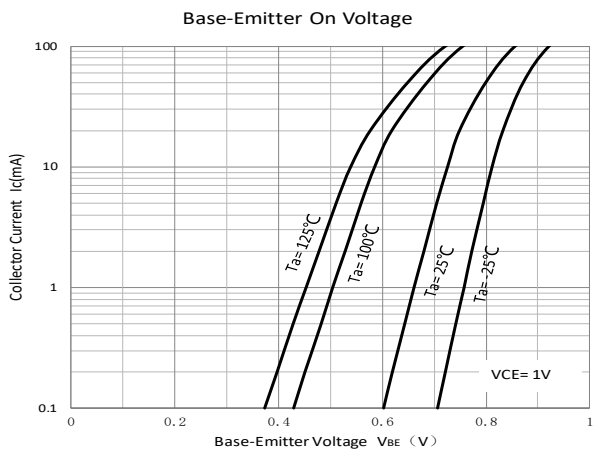
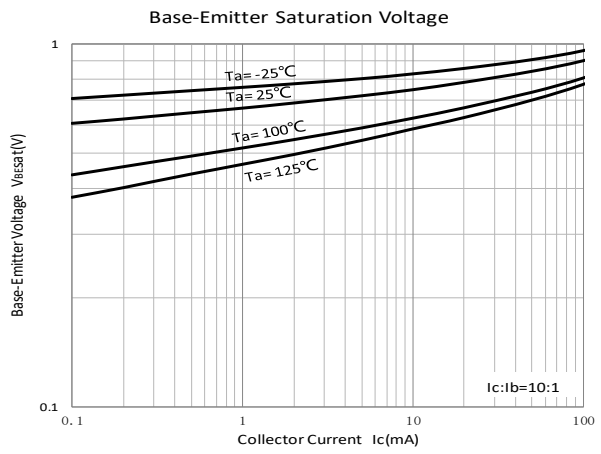
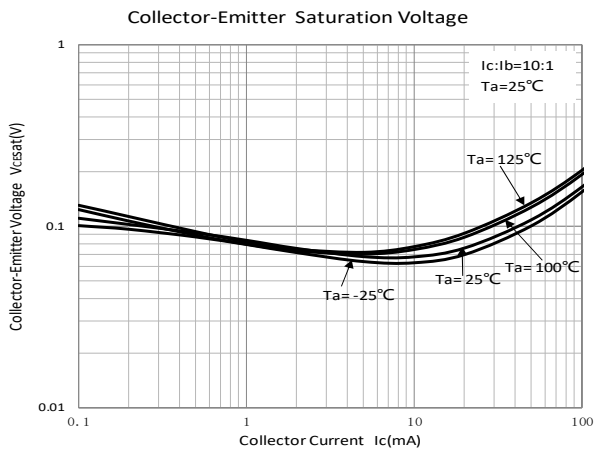
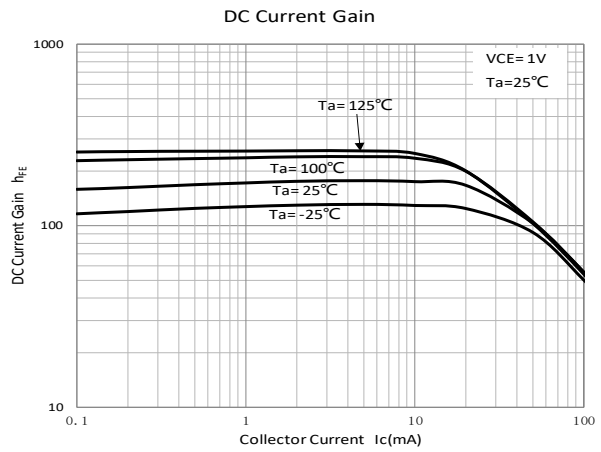
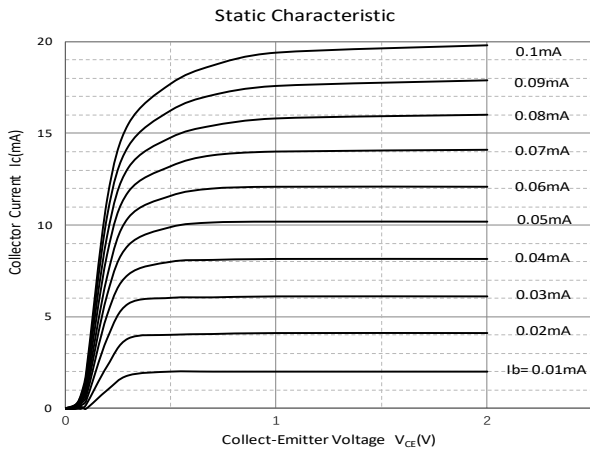



■ TR2 PNP Pin3、4、5 Characteristics (Typical)

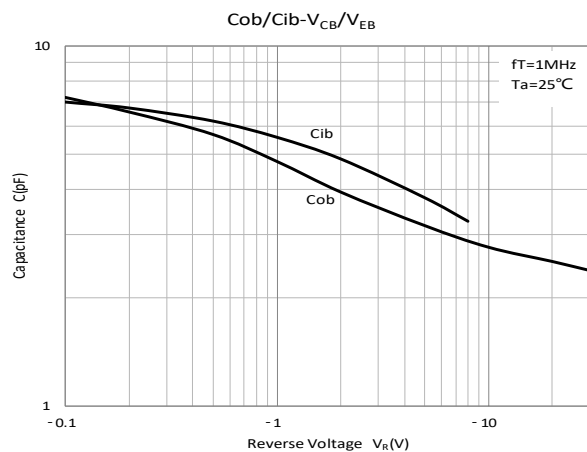
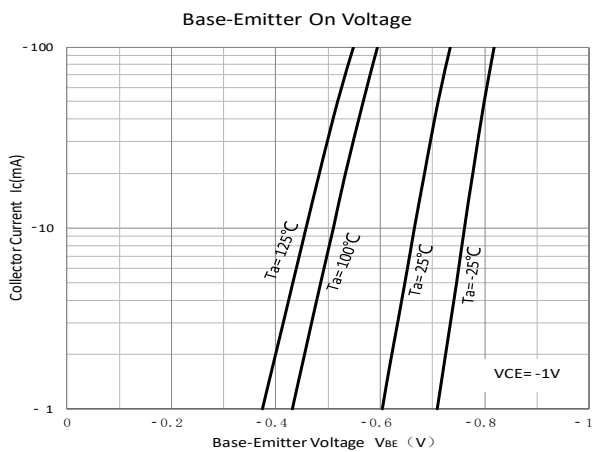
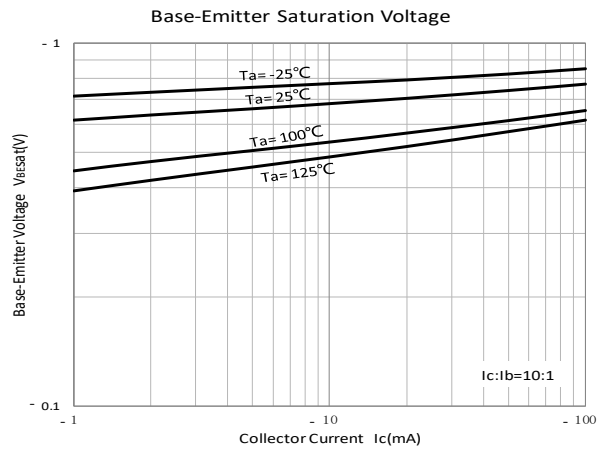
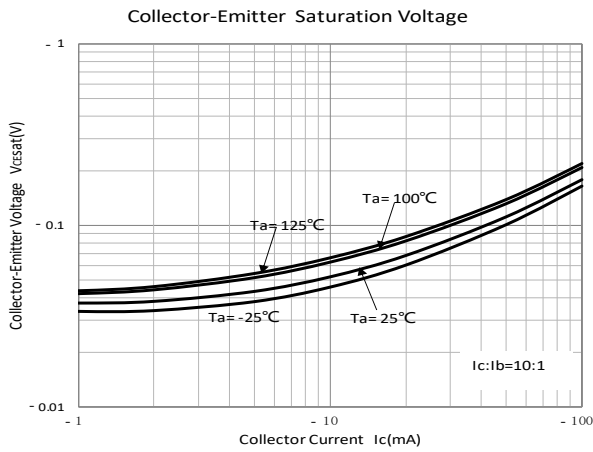
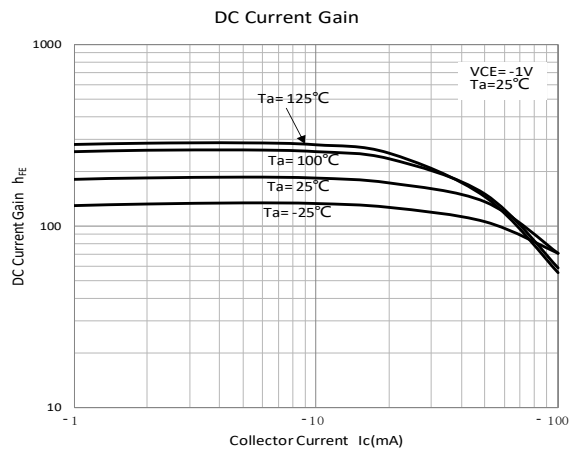
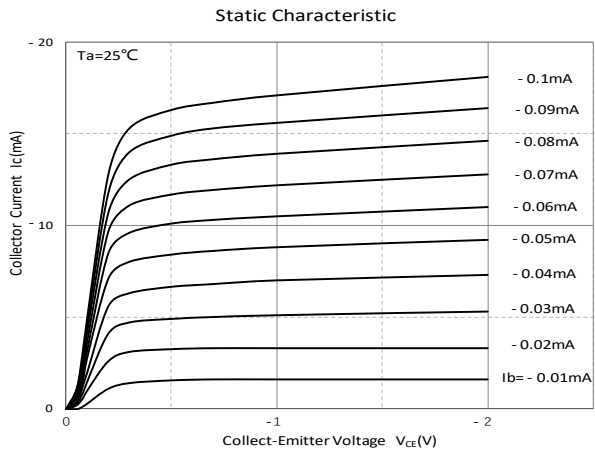



MMDT3946

■SOT-363 Package Outline Dimensions

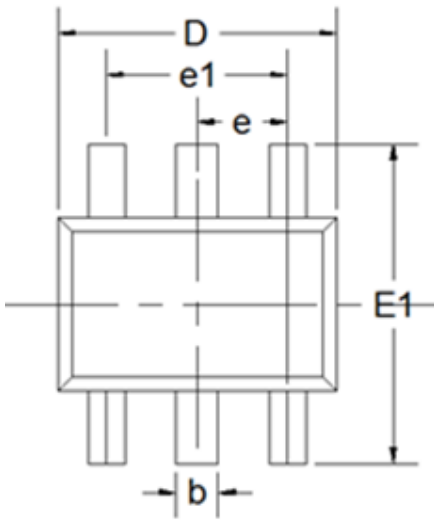

DIM	DIMENSIONS			
	INCHES		MM	
	MIN	MAX	MIN	MAX
A	0.035	0.043	0.9	1.1
A1	0	0.004	0	0.1
A2	0.035	0.039	0.9	1
b	0.006	0.014	0.15	0.35
c	0.002	0.01	0.05	0.25
D	0.071	0.087	1.8	2.2
E	0.045	0.053	1.15	1.35
E1	0.085	0.096	2.15	2.45
e	0.026Typ		0.65Typ	
e1	0.047	0.055	1.2	1.4
L	0.021Typ		0.525Typ	
L1	0.01	0.018	0.26	0.46
φ	0°	8°	0°	8°

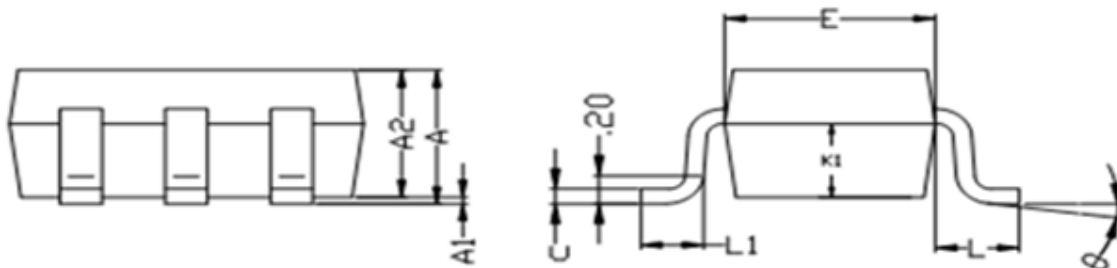

■SOT-363 Soldering Footprint

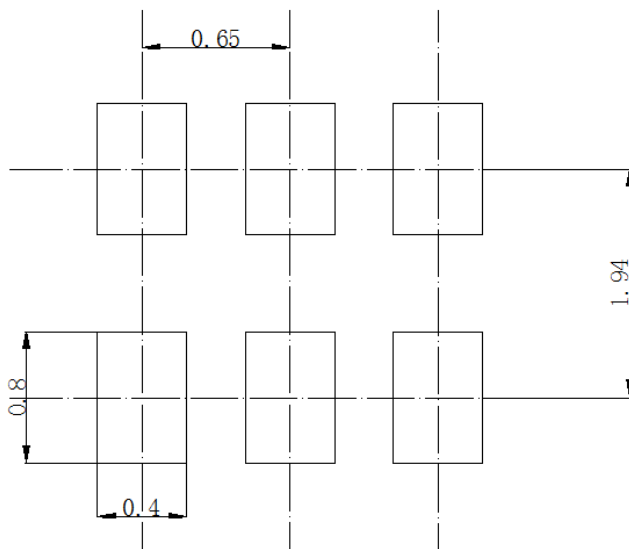

Unit: mm



Disclaimer

The information presented in this document is for reference only. Yangzhou Yangjie Electronic Technology Co., Ltd. reserves the right to make changes without notice for the specification of the products displayed herein to improve reliability, function or design or otherwise.

The product listed herein is designed to be used with ordinary electronic equipment or devices, and not designed to be used with equipment or devices which require high level of reliability and the malfunction of which would directly endanger human life (such as medical instruments, transportation equipment, aerospace machinery, nuclear-reactor controllers, fuel controllers and other safety devices), Yangjie or anyone on its behalf, assumes no responsibility or liability for any damages resulting from such improper use of sale.

This publication supersedes & replaces all information previously supplied. For additional information, please visit our website [http:// www.21yangjie.com](http://www.21yangjie.com) , or consult your nearest Yangjie's sales office for further assistance.